

# B-26 Marauder

USAAF, 344th Bomb Group, 497th Squadron

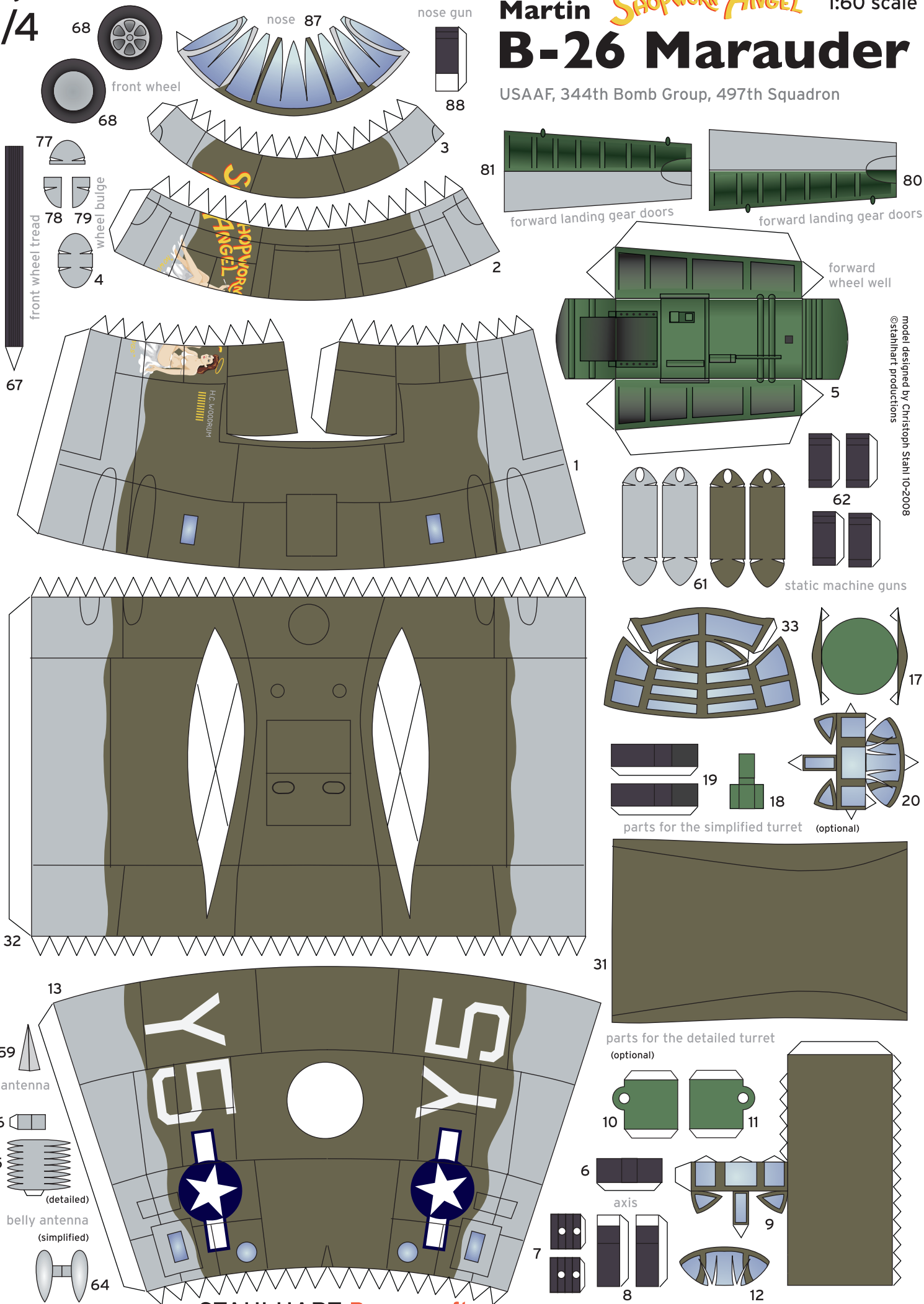

model designed by Christoph Stahl 10-2008  
©stahlhart productions

Instructions  
downloaded  
separately!

# Martin B-26 Marauder

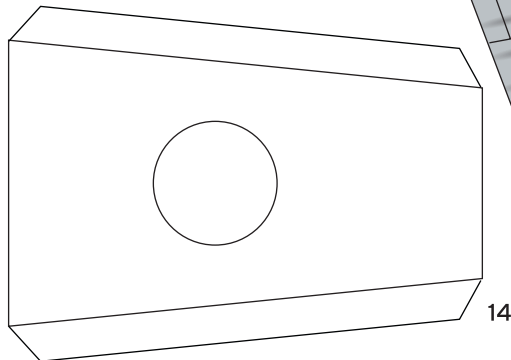
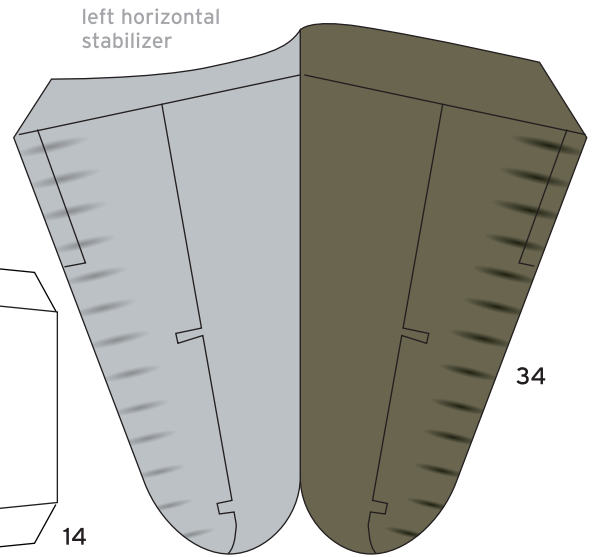
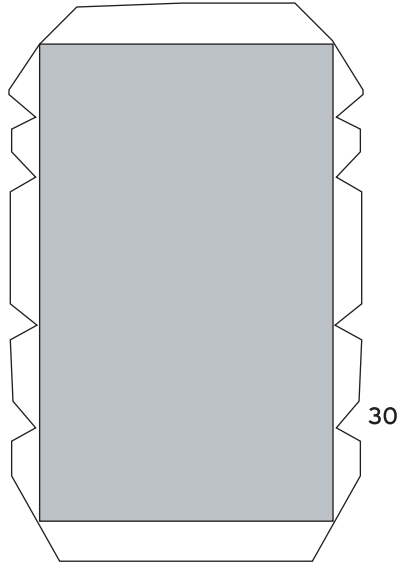
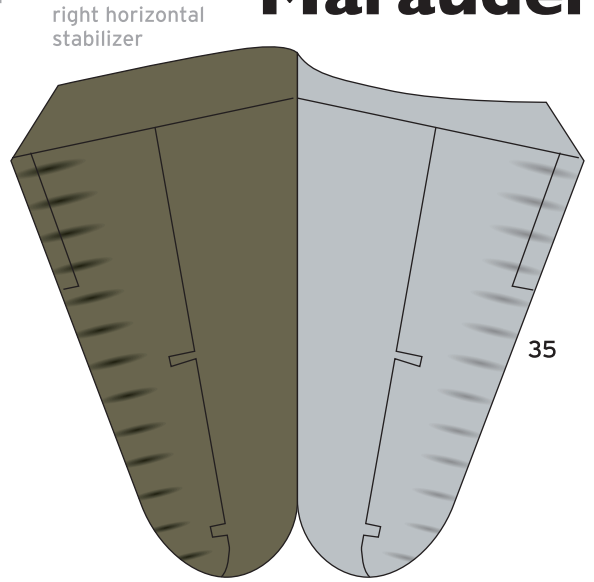
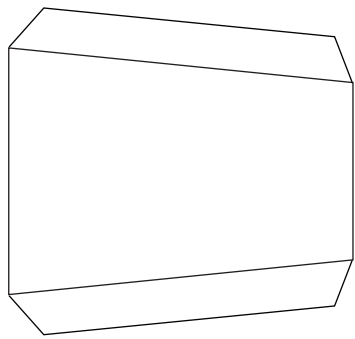
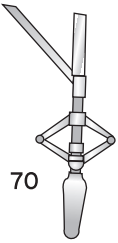
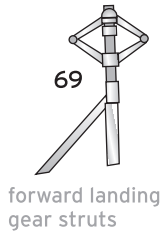

Upper stabilizer piece

Rear Gunner Cabin

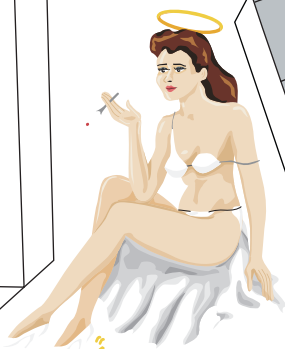
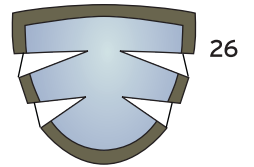

"NOWINGS"

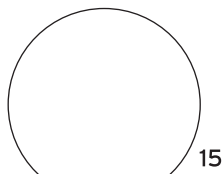
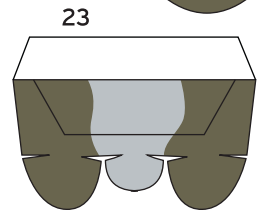
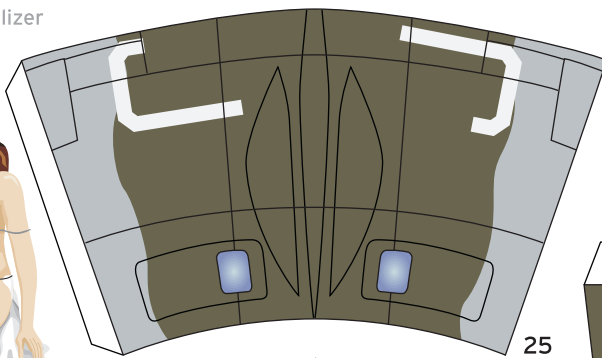

Turret lower end

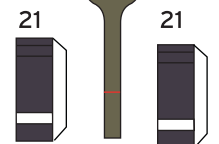
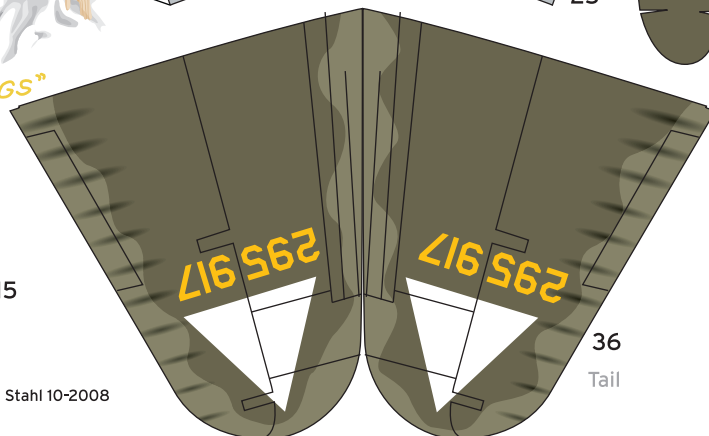

Main wing  
inner stabilizer

25

landing gear detail (optional)

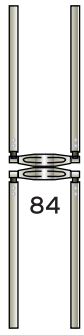
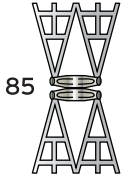

propeller shaft hub

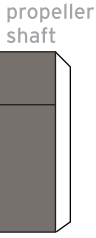

propeller shaft

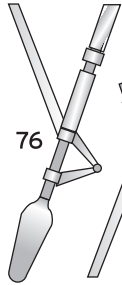

main landing gear struts

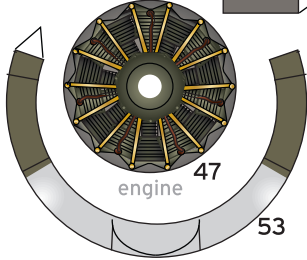

engine

53

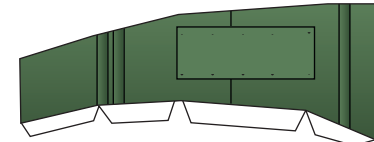

landing gear well

42

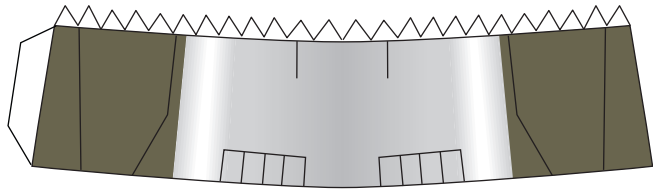

engine 51

52

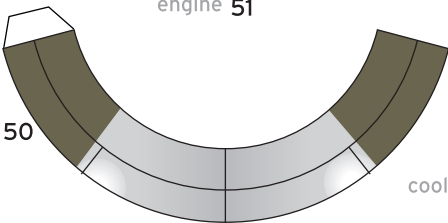
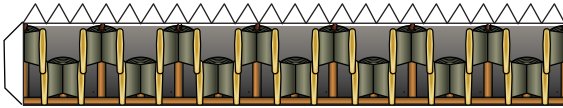

50

58 cooler

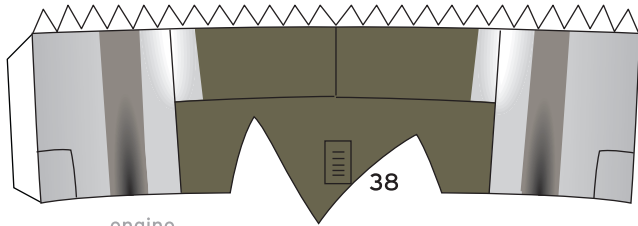

38

engine

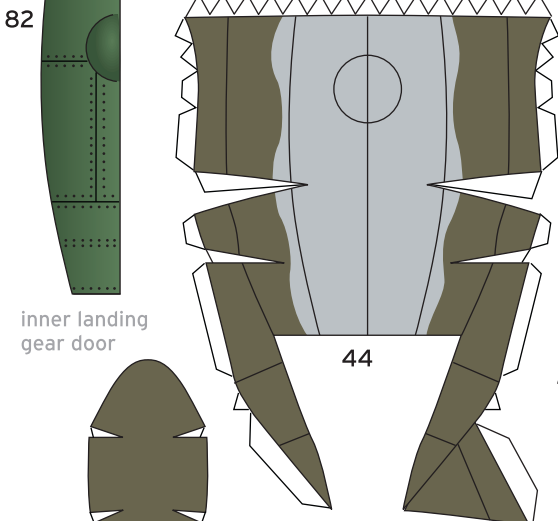

44

inner landing gear door



58 cooler

71

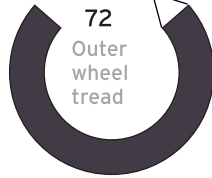

72

Outer wheel tread

wheel tread

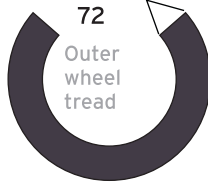

72

Outer wheel tread



73

rim



74

rim

63 exhaust

63 exhaust

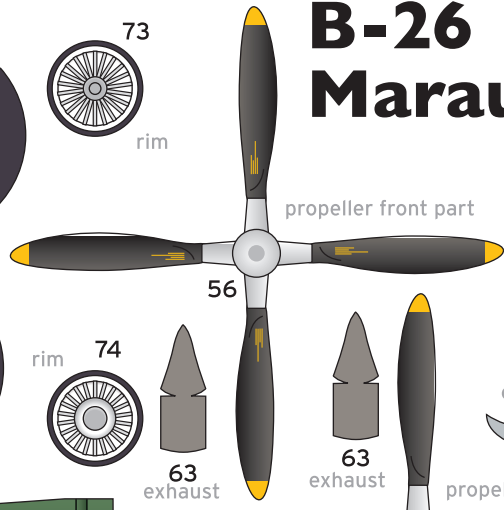

propeller front part

56

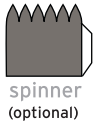

spinner (optional) 86

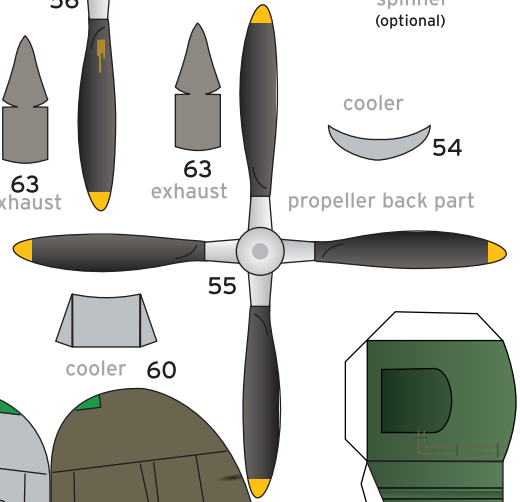

propeller back part

55



cooler 54



cooler 60

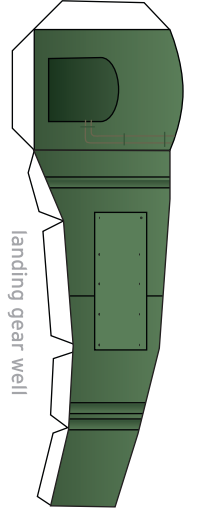

landing gear well

40

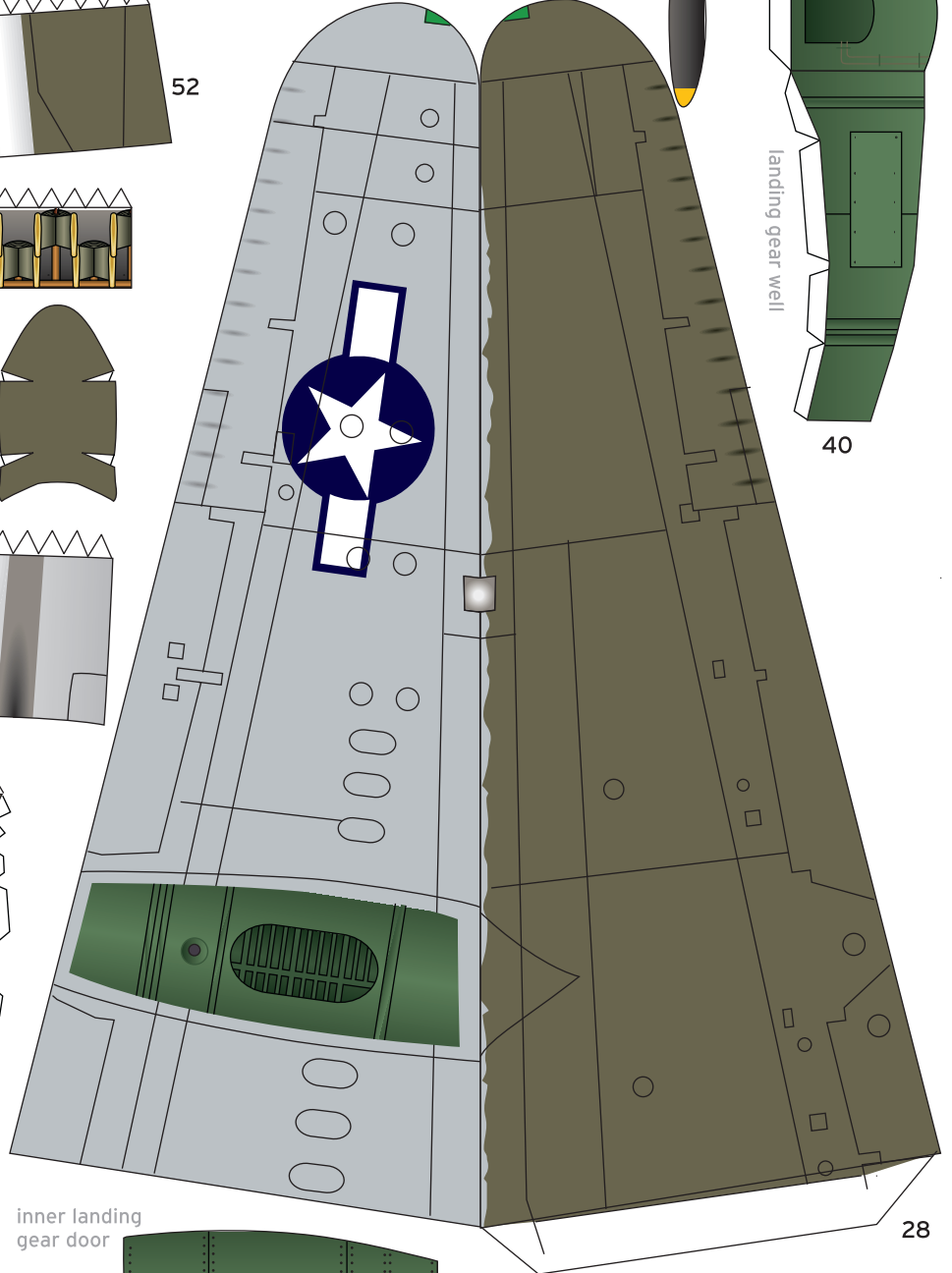

28

# Martin B-26 Marauder

